

Cell Type UF463450F

Specifications

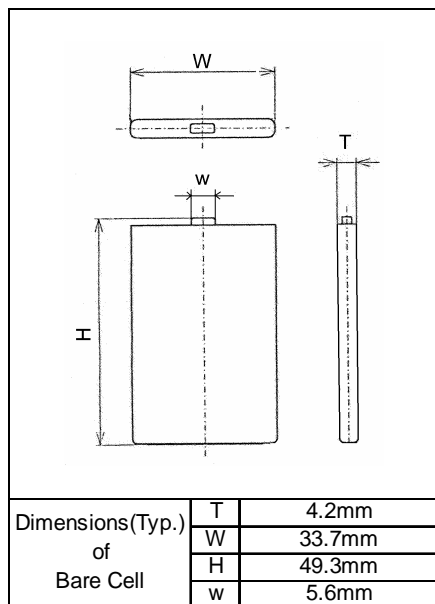

Nominal Capacity		Min.920mAh
Nominal Voltage		3.7V
Charging Method		Constant Current -Constant Voltage
Charging Voltage		4.2V
Charging Current		Std. 920mA
Charging Time		2.5hrs.
Ambient Temperature	Charge	0~+40°C
	Discharge	-20~+60°C
	Storage	-20~+50°C
Weight (Max.)		18.5g
Dimensions (Max.)	(T)	4.45mm
	(W)	33.85mm
	(H)	49.60mm
Volumetric Energy Density		455Wh/l
Gravimetric Energy Density		184Wh/kg

Discharged State after Assembling

*The maximum thickness of the standard shipment charging condition

Typical Characteristics

Discharge rate characteristics

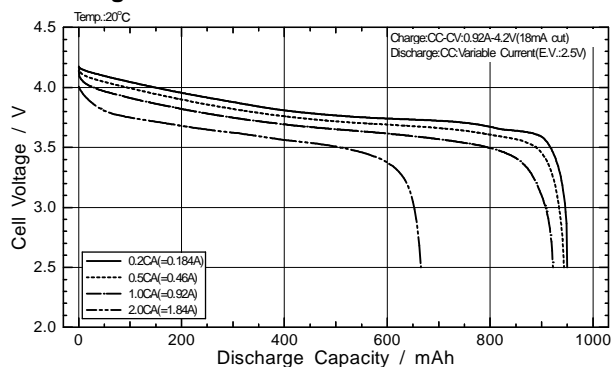

Discharge temperature characteristics

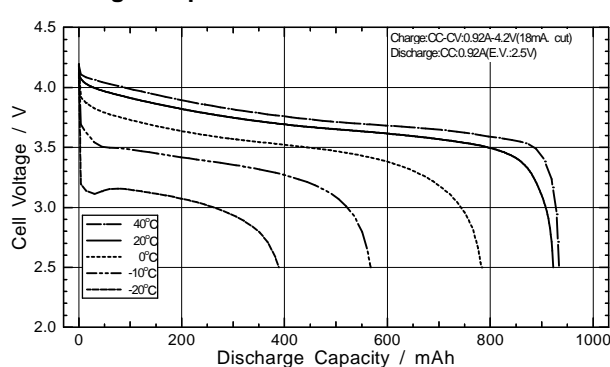

Charge characteristics

